

BMA253 Shuttle Board

GENERAL DESCRIPTION

The Bosch Sensortec BMA253 shuttle-board is a PCB with a BMA253 acceleration sensor mounted on it. It allows easy access to the sensors pins via a simple socket. As all Bosch Sensortec sensor shuttle boards have identical footprint, they can be plugged into Bosch Sensortec's advanced development tools (e.g. the Development Board). Of course, the BMA253 shuttle board can also be used for customer's own implementations.

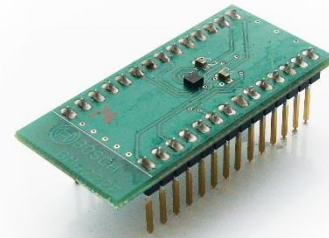

Note: Product photo may differ from real product's appearance.

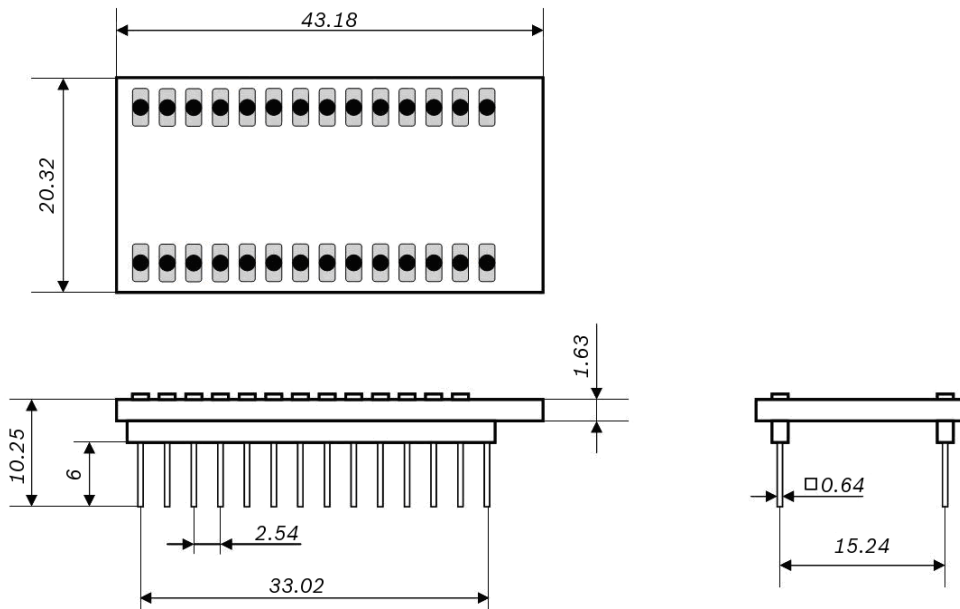

Shuttle board outline dimensions (all dimensions in mm)

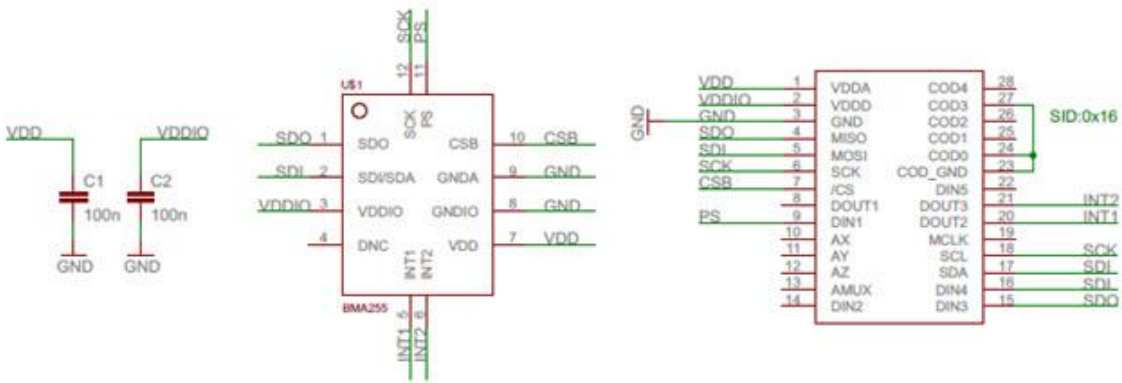

BMA253 shuttle board electrical layout

DELIVERABLES

- ▶ BMA253 shuttle board

Headquarters
Bosch Sensortec GmbH
 Gerhard-Kindler-Strasse 9
 72770 Reutlingen · Germany
 Telephone +49 7121 3535 900
 Fax +49 7121 3535 909

www.bosch-sensortec.com